

# SIMPLEXA 601 top

Item no.: 6010130

**theben**  
energy saving comfort

Time and light control  
Digital time switches

## Description

- Digital time switch with weekly program
- 1 channel
- Screw terminals (4 mm<sup>2</sup>)
- 42 memory locations
- 48 hours power reserve (rechargeable)
- ON-OFF switching times
- Permanent ON/OFF switching
- Automatic summer/winter time changeover
- PIN coding
- Circuit preselection



## Technical data

SIMPLEXA 601 top	
Operating voltage	230 V AC
Frequency	50 – 60 Hz
Width	2 modules
Installation type	DIN rail
Type of contact	NO contact
Opening width	< 3 mm (μ)
Program	Weekly program
Program functions	EIN-AUS
Number of channels	1

SIMPLEXA 601 top	
Number of memory locations	42
Power reserve	48 hours
Switching capacity at 250 V AC, cos φ = 1	16 A
Switching capacity at 250 V AC, cos φ = 0,6	2 A
Incandescent/halogen lamp load	2600 W
LED lamp < 2 W	30 W
LED lamp 2-8 W	300 W
LED lamp > 8 W	300 W

Subject to technical changes and misprints  
additional information at: [www.theben.de/product/6010130](http://www.theben.de/product/6010130)

The load data are determined with exemplary selected illuminants and are therefore typical data due to the large number of available products.

# SIMPLEXA 601 top

Item no.: 6010130

**theben**  
energy saving comfort

## Technical data

SIMPLEXA 601 top	
Shortest switching times	1 min
Time accuracy at 25 °C	$\leq \pm 0.5$ s/day (quartz)
Time basis	Quartz
Stand-by consumption	~0.55 W
Type of connection	Screw terminals
Display	LCD-Anzeige mit Textzeile
Keyboards	4 touch buttons

SIMPLEXA 601 top	
Drive	Quartz-controlled stepper motor
Housing and insulation material	High-temperature resistant, self-extinguishing thermoplastic
Type of protection	IP 20
Protection class	II according to EN 60 730-1
Ambient temperature	-30°C ... 55°C

## Scale drawings

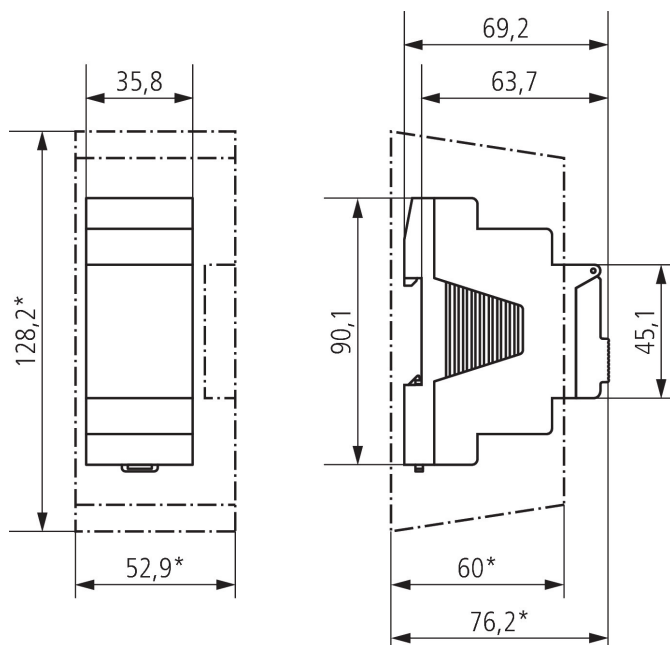

## Accessories

### Wall mounting kit 35 mm

Item no.: 9070064



### Front panel kit

Item no.: 9070001



Subject to technical changes and misprints

additional information at: [www.theben.de/product/6010130](http://www.theben.de/product/6010130)

The load data are determined with exemplary selected illuminants and are therefore typical data due to the large number of available products.

06/09/2021

Page 2 of 2